

1N4001W THRU 1N4007W

Surface Mount General Purpose Silicon Rectifiers

Reverse Voltage - 50 to 1000 V

Forward Current - 1 A

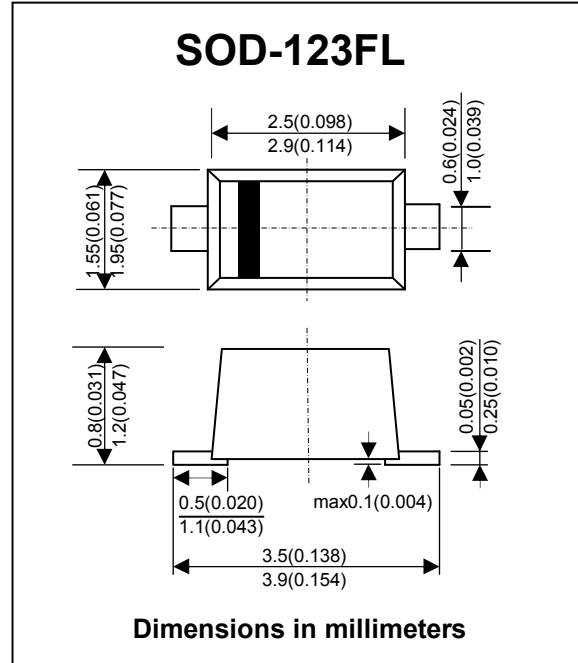

Maximum Ratings and Electrical characteristics

Ratings at 25°C ambient temperature unless otherwise specified.

Single phase half-wave 60 Hz, resistive or inductive load, for capacitive load current derate by 20 %.

Parameter	Symbols	1N4001W	1N4002W	1N4003W	1N4004W	1N4005W	1N4006W	1N4007W	Units
Maximum Repetitive Peak Reverse Voltage	V_{RRM}	50	100	200	400	600	800	1000	V
Maximum RMS voltage	V_{RMS}	35	70	140	280	420	560	700	V
Maximum DC Blocking Voltage	V_{DC}	50	100	200	400	600	800	1000	V
Maximum Average Forward Rectified Current at $T_a = 65^\circ\text{C}$	$I_{F(AV)}$	1							A
Peak Forward Surge Current 8.3 ms Single Half Sine Wave Superimposed on Rated Load (JEDEC Method)	I_{FSM}	25							A
Maximum Instantaneous Forward Voltage at 1 A	V_F	1.1							V
Maximum DC Reverse Current $T_a = 25^\circ\text{C}$ at Rated DC Blocking Voltage $T_a = 125^\circ\text{C}$	I_R	5 50							μA
Typical Junction Capacitance ¹⁾	C_j	4							pF
Typical Thermal Resistance ²⁾	$R_{\theta JA}$	180							$^\circ\text{C/W}$
Operating and Storage Temperature Range	T_j, T_{stg}	- 55 to + 150							$^\circ\text{C}$

¹⁾ Measured at 1 MHz and applied reverse voltage of 4 V D.C

²⁾ Thermal resistance from junction to ambient at 0.375" (9.5 mm) lead length, P.C.B. mounted

FIG.1 – TYPICAL FORWARD CHARACTERISTIC

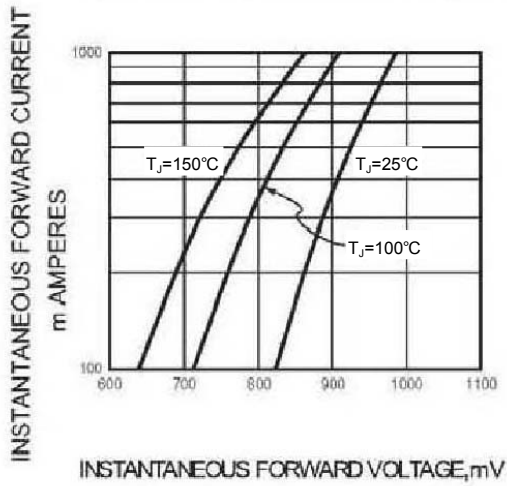

FIG.2 – TYPICAL JUNCTION CAPACITANCE

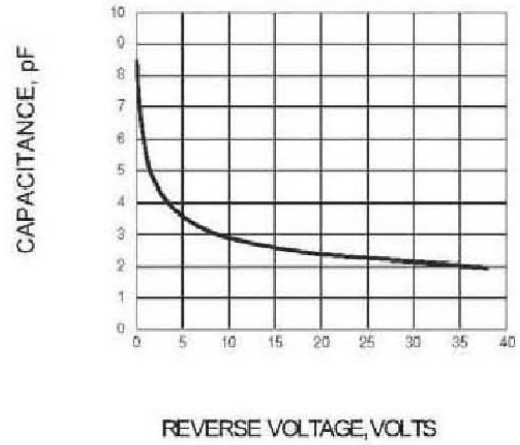

FIG.3 – TYPICAL INSTANTANEOUS REVERSE CHARACTERISTICS

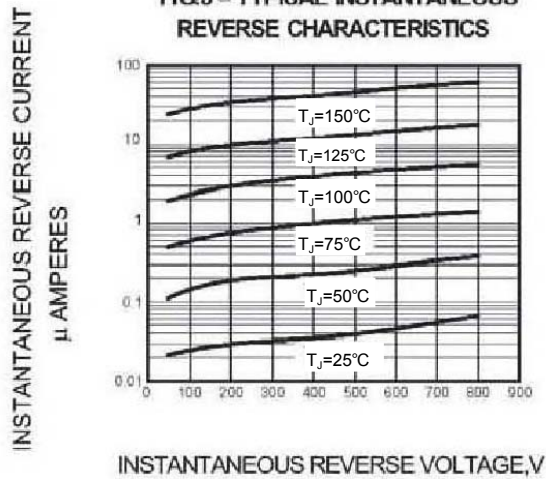
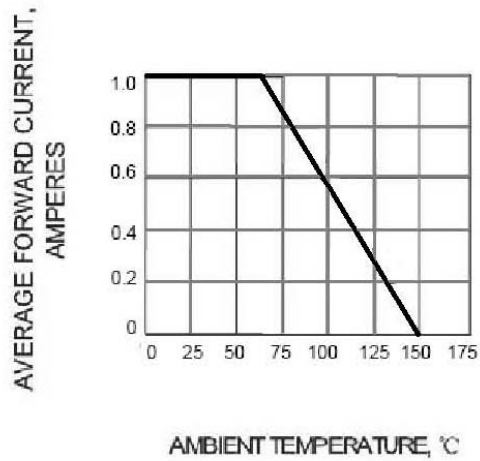

FIG.4 – FORWARD DERATING CURVE



PACKAGE OUTLINE

Plastic surface mounted package; 2 leads

SOD-123FL

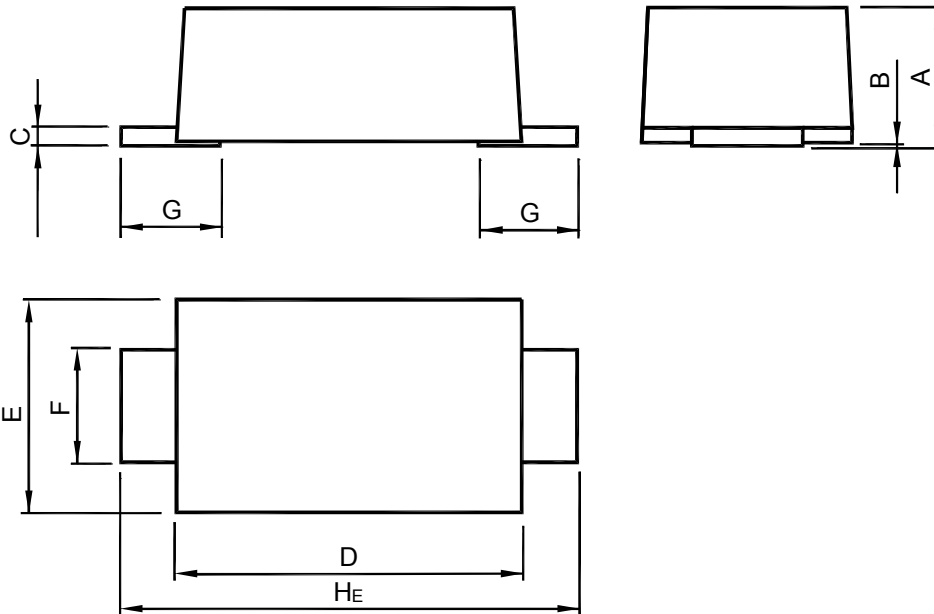

UNIT	A	B	C	D	E	F	G	H _E
mm	1.08	0.1	0.2	2.9	1.9	1.1	0.9	3.9
	0.88	0	0.1	2.6	1.7	0.8	0.7	3.5

RECOMMENDED SOLDERING FOOTPRINT

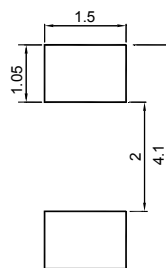

SOD-123FL